

The RF Line

Microwave Pulse Power Transistor

Designed for Class B and C common base amplifier applications in short pulse TACAN, IFF, and DME transmitters.

- Guaranteed Performance @ 1090 MHz, 50 Vdc
Output Power = 150 Watts Peak
Minimum Gain = 7.8 dB
- 100% Tested for Load Mismatch at All Phase Angles with 10:1 VSWR
- Industry Standard Package
- Nitride Passivated
- Gold Metallized, Emitter Ballasted for Long Life and Resistance to Metal Migration
- Internal Input Matching for Broadband Operation

MRF1150MB

**150 W PEAK, 960–1215 MHz
MICROWAVE POWER
TRANSISTOR
NPN SILICON**

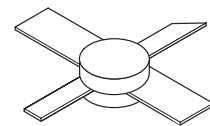

CASE 332A-03, STYLE 1

MAXIMUM RATINGS

Rating	Symbol	Value	Unit
Collector–Base Voltage	V_{CBO}	70	Vdc
Emitter–Base Voltage	V_{EBO}	4.0	Vdc
Collector Current — Peak (1)	I_C	12	Adc
Total Device Dissipation @ $T_C = 25^\circ\text{C}$ (1) (2) Derate above 25°C	P_D	583 3.33	Watts W/ $^\circ\text{C}$
Storage Temperature Range	T_{stg}	-65 to +150	$^\circ\text{C}$

THERMAL CHARACTERISTICS

Characteristic	Symbol	Max	Unit
Thermal Resistance, Junction to Case (3)	$R_{\theta JC}$	0.3	$^\circ\text{C}/\text{W}$

ELECTRICAL CHARACTERISTICS ($T_C = 25^\circ\text{C}$ unless otherwise noted)

Characteristic	Symbol	Min	Typ	Max	Unit
----------------	--------	-----	-----	-----	------

OFF CHARACTERISTICS

Collector–Emitter Breakdown Voltage ($I_C = 50$ mAdc, $V_{BE} = 0$)	$V_{(BR)CES}$	70	—	—	Vdc
Collector–Base Breakdown Voltage ($I_C = 50$ mAdc, $I_E = 0$)	$V_{(BR)CBO}$	70	—	—	Vdc
Emitter–Base Breakdown Voltage ($I_E = 5.0$ mAdc, $I_C = 0$)	$V_{(BR)EBO}$	4.0	—	—	Vdc
Collector Cutoff Current ($V_{CB} = 50$ Vdc, $I_E = 0$)	I_{CBO}	—	—	10	mAdc

ON CHARACTERISTICS

DC Current Gain (4) ($I_C = 5.0$ Adc, $V_{CE} = 5.0$ Vdc)	h_{FE}	10	30	—	—
---	----------	----	----	---	---

NOTES:

1. Pulse Width = 10 μs , Duty Cycle = 1%.
2. This device is designed for RF operation. The total device dissipation rating applies only when the device is operated as an RF amplifier.
3. Thermal Resistance is determined under specified RF operating conditions by infrared measurement techniques.
4. 80 μs Pulse on Tektronix 576 or equivalent.

(continued)

ELECTRICAL CHARACTERISTICS — continued ($T_C = 25^\circ\text{C}$ unless otherwise noted)

Characteristic	Symbol	Min	Typ	Max	Unit
DYNAMIC CHARACTERISTICS					
Output Capacitance ($V_{CB} = 50\text{ Vdc}$, $I_E = 0$, $f = 1.0\text{ MHz}$)	C_{ob}	—	25	32	pF
FUNCTIONAL TESTS (Pulse Width = $10\ \mu\text{s}$, Duty Cycle = 1.0%)					
Common-Base Amplifier Power Gain ($V_{CC} = 50\text{ Vdc}$, $P_{out} = 150\text{ W pk}$, $f = 1090\text{ MHz}$)	G_{PB}	7.8	9.8	—	dB
Collector Efficiency ($V_{CC} = 50\text{ Vdc}$, $P_{out} = 150\text{ W pk}$, $f = 1090\text{ MHz}$)	η	35	40	—	%
Load Mismatch ($V_{CC} = 50\text{ Vdc}$, $P_{out} = 150\text{ W pk}$, $f = 1090\text{ MHz}$, VSWR = 10:1 All Phase Angles)	ψ	No Degradation in Power Output			

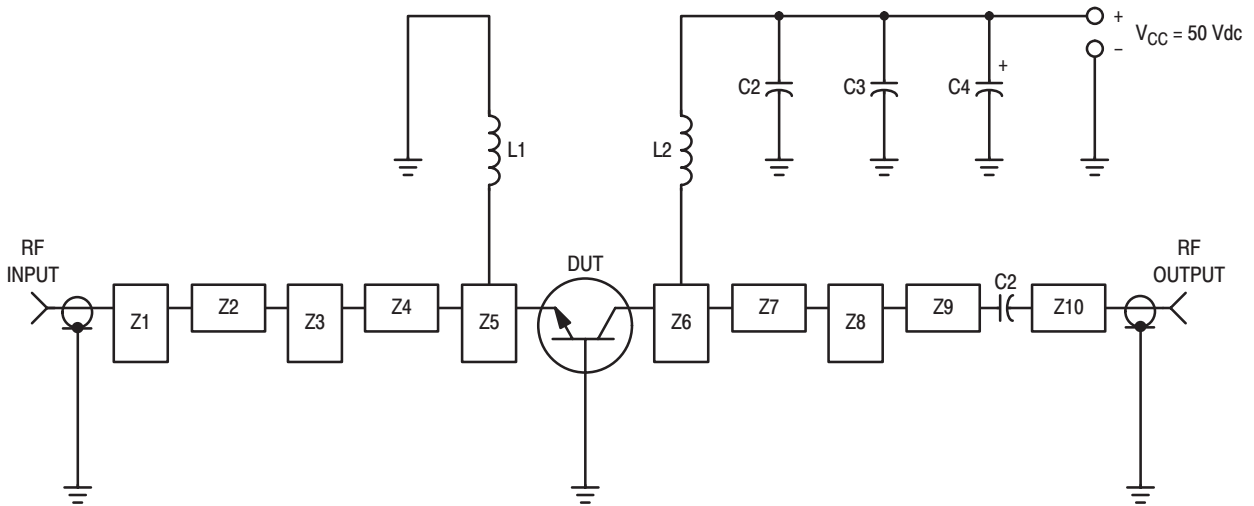

C1, C2 — 220 pF Chip Capacitor, 100-mil ATC
 C3 — 0.1 $\mu\text{F}/100\text{ V}$
 C4 — 47 $\mu\text{F}/75\text{ V}$ Electrolytic
 L1, L2 — 3 Turns #18 AWG, 1/8" ID
 Z1–Z10 — Distributed Microstrip Elements — See Photomaster
 Board Material — 0.031" Thick Teflon-Fiberglass, $\epsilon_r = 2.5$

Figure 1. 1090 MHz Test Circuit

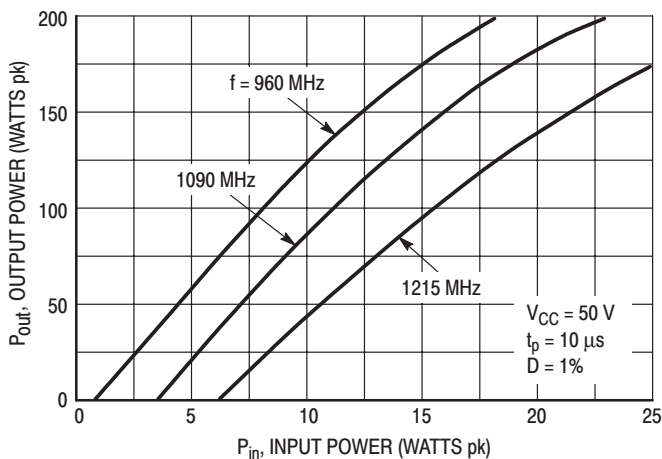

Figure 2. Output Power versus Input Power

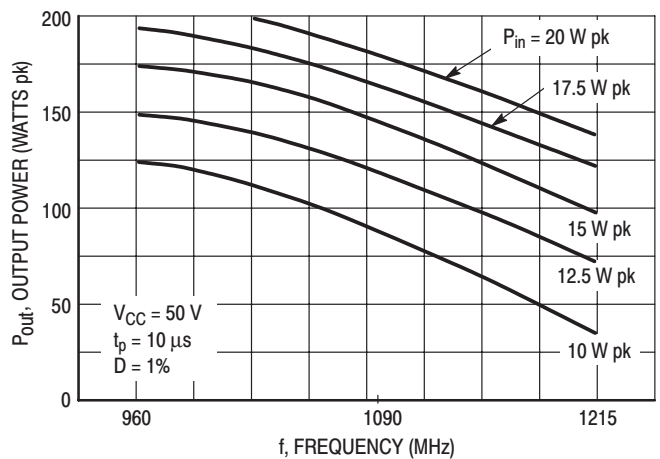

Figure 3. Output Power versus Frequency

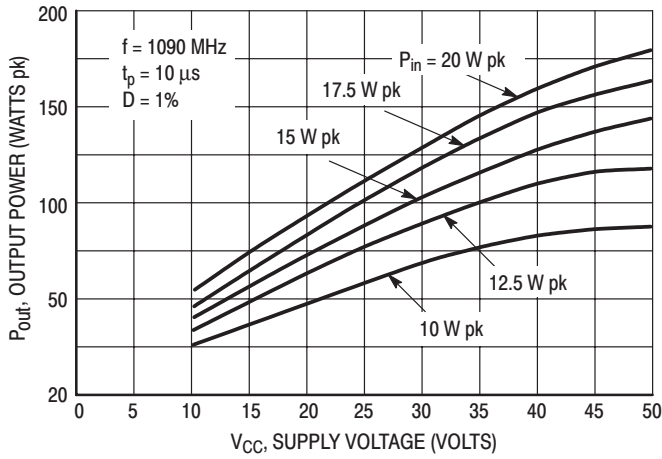

Figure 4. Output Power versus Supply Voltage

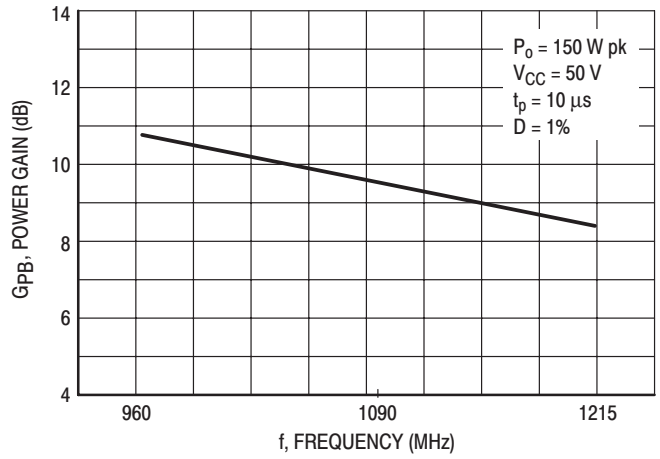
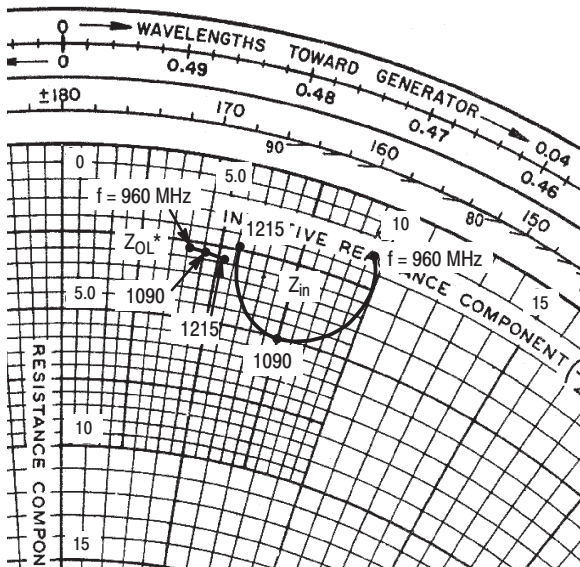

Figure 5. Power Gain versus Frequency



$P_{out} = 150 \text{ W pk}$ $V_{CC} = 50 \text{ V}$
 $t_p = 10 \mu\text{s}$ $D = 1\%$

f MHz	Z_{in} Ohms	Z_{OL}^* Ohms
960	$1.5 + j9.6$	$2.6 + j4.1$
1090	$5.0 + j7.5$	$2.7 + j4.6$
1215	$2.4 + j5.6$	$2.8 + j5.3$

Z_{OL}^* = Conjugate of the optimum load impedance into which the device output operates at a given output power, voltage, and frequency.

Figure 6. Series Equivalent Input/Output Impedance

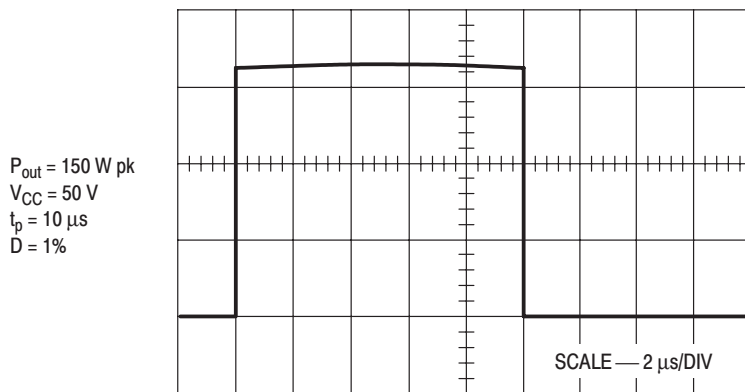
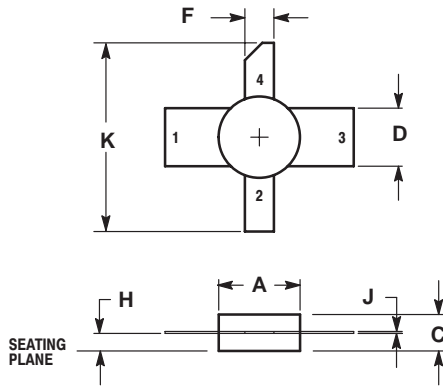

Figure 7. Typical Pulse Performance

PACKAGE DIMENSIONS



NOTES:

1. DIMENSIONING AND TOLERANCING PER ANSI Y14.5M, 1982.
2. CONTROLLING DIMENSION: INCH.

DIM	INCHES		MILLIMETERS	
	MIN	MAX	MIN	MAX
A	0.270	0.290	6.86	7.36
C	0.115	0.135	2.93	3.42
D	0.195	0.205	4.96	5.20
F	0.095	0.105	2.42	2.66
H	0.050	0.070	1.27	1.77
J	0.003	0.007	0.08	0.17
K	0.600	---	15.24	---

STYLE 1:

1. BASE
2. EMITTER
3. BASE
4. COLLECTOR

**CASE 332A-03
ISSUE D**

Specifications subject to change without notice.

- **North America:** Tel. (800) 366-2266, Fax (800) 618-8883
- **Asia/Pacific:** Tel.+81-44-844-8296, Fax +81-44-844-8298
- **Europe:** Tel. +44 (1344) 869 595, Fax+44 (1344) 300 020

Visit www.macom.com for additional data sheets and product information.

REV 0

tyco / Electronics

MACOM